

## PRODUCT INFORMATION

### TRAFFIC MANAGEMENT SENSOR

UMRR-11 Type 45



s.m.s, smart microwave sensors GmbH  
In den Waashainen 1  
38108 Braunschweig  
Germany

Phone: +49 531 39023-0  
Fax: +49 531 39023-599  
info@smartmicro.de  
www.smartmicro.com

## CONTENT

1	USER SAFETY WARNING .....	3
2	SENSOR SPECIFICATIONS.....	5
2.1	MEASUREMENT PRINCIPLE.....	5
2.2	SENSOR DIMENSIONS .....	7
2.3	SENSOR CONNECTOR.....	8
2.4	SENSOR AND HARDWARE IDENTIFICATION .....	9
3	GENERAL PERFORMANCE DATA.....	10
3.1	SELF-DIAGNOSIS.....	11
3.2	SENSOR NETWORK.....	11
3.3	ETHERNET CONNECTION .....	12
4	APPLICATION-SPECIFIC CHARACTERISTICS.....	13
4.1	INTERSECTION MANAGEMENT .....	13
4.2	HIGHWAY MANAGEMENT.....	14
4.3	TRAFFIC ENFORCEMENT.....	15
5	COMPLIANCES.....	16
6	LEGAL DISCLAIMER NOTICE .....	17

## 1 USER SAFETY WARNING

Please read the entire document carefully before using the sensor.

### INSTALLATION

Please pay attention to the details below before installing and connecting the sensor:

- Only use provided or approved equipment for the installation. Use stainless screws with the given metric thread. If other brackets than those provided are used, screw lengths must be adapted.
- Only skilled and instructed persons shall install and connect the sensor. Proper experience in working with mains voltage, electrical and electronic devices is required.
- Do not connect the sensor directly to the mains voltage; instead use the voltage specified for the product.
- Do not wire any connections when power is applied to the device.
- Ground devices carefully to prevent electrical shock.
- All connectors are pin-coded and fit in only one position. Also note the arrow indicating the top side of the sensor.
- Only use fully functional equipment (ladders, aerial work platform, etc.) when working above ground. Staff shall be capable of working at heights.
- Be cautious when installing the sensor on or around active roadways and pay attention to moving traffic.
- Mount the sensor carefully to prevent it from shifting or dropping.
- The sensor must be mounted to a stiff and solid support. Vibration, oscillation or other movement will reduce the sensor performance.
- Make sure that installation methods are in accordance with local safety policies and procedures as well as company practices.

### OPERATION

Do not operate the sensor if the device itself or any cables are damaged.

Transmission of radio frequency waves starts after the sensor is powered up and stops when it is disconnected from power.

Using a J-Box or SRO does not influence the sensor performance. It is recommended that only one connection interface is used at a time.

For testing purposes, the sensor may be laid on its face when it is powered up, given that the surface or connectors will not be damaged this way. Please note that this position is not intended for permanent use.



The sensor may become hot during operation. Proper hand protection is recommended for maintenance work.



Do not dispose electrical and electronic equipment in household trash.

### **TECHNICAL SERVICE**

Only use provided or approved equipment for operation. People other than authorized and approved electrical technicians shall NOT attempt to connect the device to a power supply, the Traffic Management Interface Board (TMIB) or other controllers, as there is a risk of electrical shock by unsafe handling of the power source.

Do not attempt to service or repair this device:

- No user-maintainable parts are contained in the device.
- To avoid electrical shock, do not remove or open the cover.
- Unauthorized opening will void all warranties.
- smartmicro is not liable for any damages or harms caused by unauthorized attempts to open or repair the device.

### **RADIATION**

This product has been tested and found to comply with Part 15 Subpart C of the Federal Communications Commission (FCC) or the European RED directive, or other national rules, depending on the country where it may be in use.

Operation is subject to the following two conditions:

- This device may not cause harmful interference.
- This device must accept any interference received, including interference that may cause undesired operation.

This device generates radio frequency energy. There are strict limits on continuous emission power levels to provide reasonable protection against harmful interference when the equipment is operated in a commercial environment.

- Human exposure to transmitted waves from this device is generally considered as safe. Still, it is considered good practice that humans are not subject to higher radiation levels than necessary.

This device may interfere with other devices using the same frequency band.

## 2 SENSOR SPECIFICATIONS

UMRR-11 Type 45 is a 24GHz radar sensor for multi-lane, multi-object tracking traffic management applications that features 4D/HD technology.

For each smartmicro radar generation, several different antennas are available, so the field of view and maximum range can be selected as needed from the available models. Type 45 antenna aims at a long range.

### 2.1 MEASUREMENT PRINCIPLE

The sensor measures range, radial speed, horizontal and vertical angle, reflectivity and more parameters of multiple stationary and moving reflectors (targets) simultaneously. It is capable of high definition (4D/HD), where HD resolution means that the sensor can separate objects regarding their speed, their distance to the sensor, and their azimuth angle.

The sensor is almost unaffected by weather, temperature and lighting conditions.

#### 4D/HD MEASUREMENT

A 4D Doppler based radial motion detection principle is integrated:

- a) Direct unambiguous Doppler measurement (speed)
- b) Direct range measurement
- c) Direct azimuth angle measurement (horizontal angle)
- d) Direct elevation angle measurement (vertical angle)

Moving reflectors with an absolute radial speed component of typically  $>0.1\text{m/s}$  can be detected as well as stationary objects.

With its multi-target capability, the sensor can *detect* many reflectors within the field of view at a time (max. 128 or 256<sup>1</sup>). The field of view typically covers up to four lanes. Additionally, filter algorithms are implemented for the tracking of all detected reflectors over time. Those tracking algorithms are integrated in the sensor. Multiple objects (max. 64 or 126<sup>1</sup>) can be *tracked* simultaneously. Depending on the selected communication interface, the number of *reported* targets and objects may be limited, for example when using RS485 interface. Both, targets and objects, are sorted by range; those with short range are reported first.

The result of tracking is an object list with the following parameters:

- X-position
- Y-position
- Absolute velocity
- Heading angle
- Length
- Object ID and more

The sensor reports such a list of all tracked objects in every measurement cycle of typically 75ms or 58ms length (depending on the configuration).

<sup>1</sup> For this parameter special firmware is needed.

### HIGH DEFINITION RESOLUTION - OBJECT SEPARATION PERFORMANCE

The sensor can separate objects even in areas where many vehicles are closely spaced: for example, in multi-lane scenarios with dense traffic like traffic jams, stop-and-go traffic or at busy intersections. The sensor divides the field of view into range gates and performs a Doppler (speed) measurement separate for each individual range gate.

Individual reflectors are separated by detection algorithms if having either:

- A different radial speed value (difference  $>0.35\text{m/s}$  or  $>1.15\text{ft/s}$ ) or
- A different range value by  $2\text{m}$  ( $6.5\text{ft}$ ) or  $4.5\text{m}$  ( $14.7\text{ft}$ ) depending on the selected bandwidth
- A different azimuth angle by  $20^\circ$

Tracking algorithms and the data base further support the separation of objects:

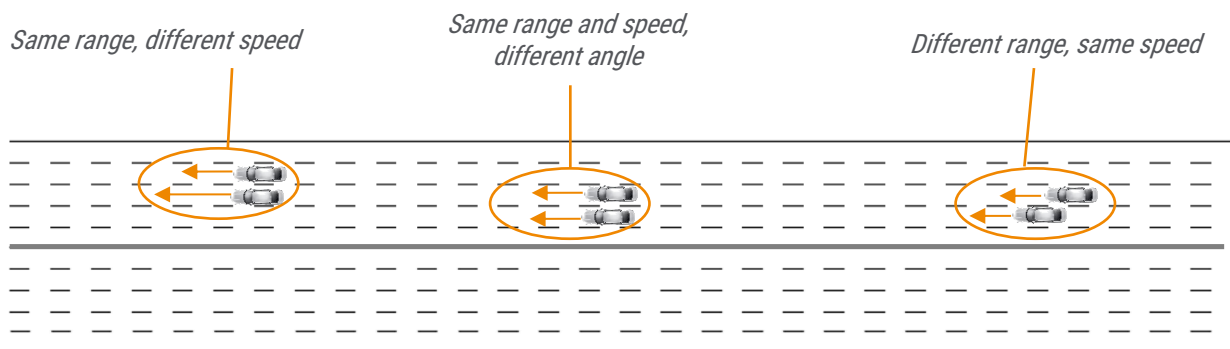

## 2.2 SENSOR DIMENSIONS

All values are given in mm.

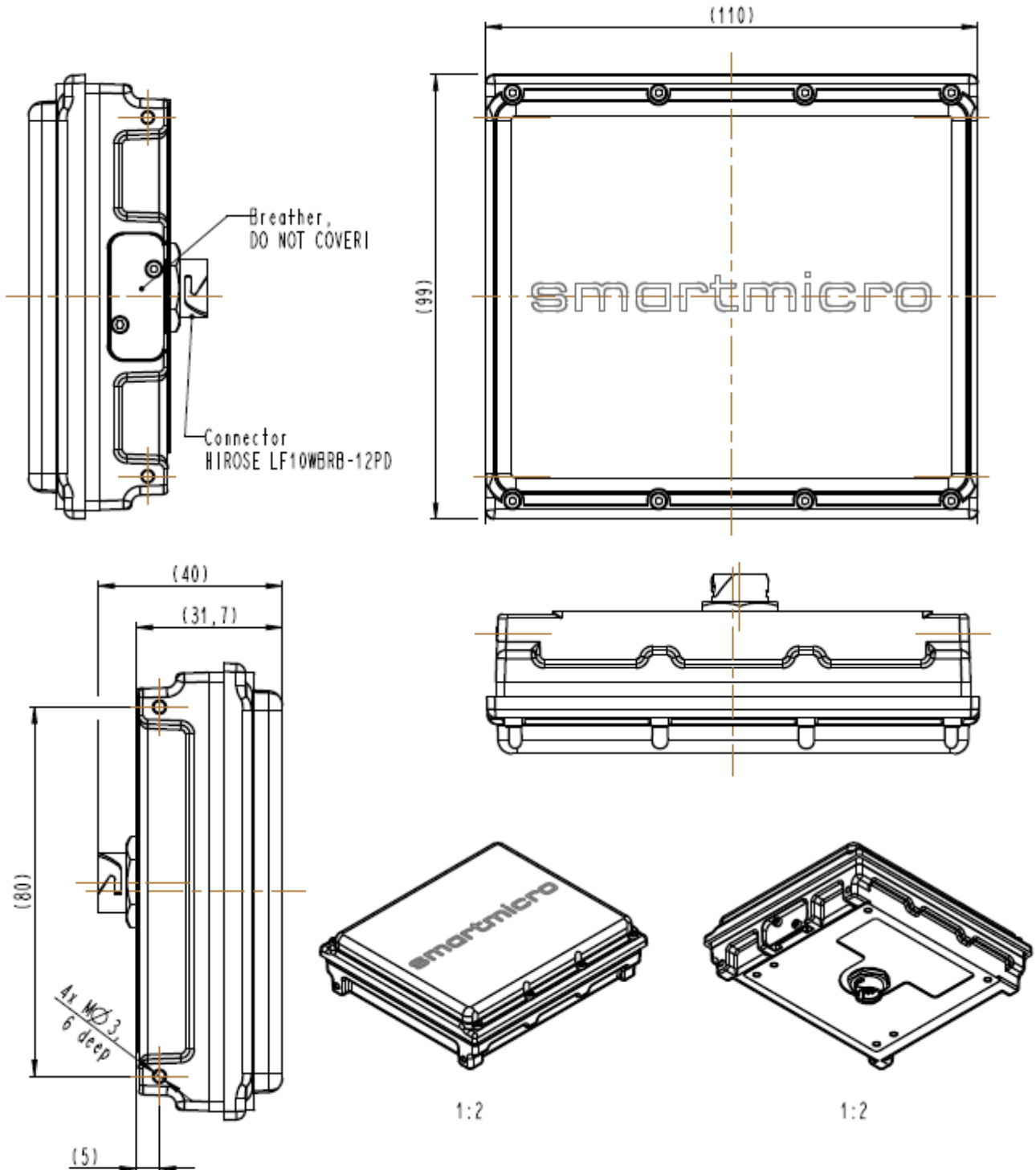

### 2.3 SENSOR CONNECTOR

The sensor connector is a 12-pin male (plug) circular bayonet type connector (waterproof IP67, series LF10WBRB-12PD, manufacturer Hirose, Japan). A female counterpart (socket), e.g. LF10WBP-12S, must be used to connect with the sensor.

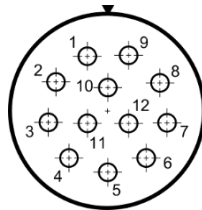

*View on solder cup side of socket showing the pin numbering (rear view of female counterpart to be connected to sensor)*

Sensor connector pin out model giving pin descriptions:

Pin No.	Function	Wire Color (MEDI type #KU110C12J002)
1	Sensor Ethernet TX H	Gray / red
2	Sensor Ethernet TX L	Red / blue
3	Sensor RS485 RX L	Pink
4	Sensor RS485 RX H	Gray
5	Sensor RS485 TX L	Brown
6	Sensor RS485 TX H	White
7	Sensor_GND	Blue
8	Sensor_Vcc	Red
9	Sensor Ethernet RX L	Black
10	Sensor Ethernet RX H	Purple
11	CAN H	Green
12	CAN L	Yellow

Please note that in the standard configuration the sensor does have a 120 Ohms resistor on board (CAN bus termination between CAN L and CAN H). Likewise, for the RS485 data interface there is a 120 Ohms resistor on board of the sensor. This resistor is required at either end of a CAN / RS485 bus.

Several cable sets for initial operation and test purposes are offered by smartmicro, to deliver a fast set-up of a sensor system. Among those preconfigured ready-to-run cables as well as cable stumps (pig tail cables or various lengths) which carry the connector on one side and open wires on the other.



## 2.4 SENSOR AND HARDWARE IDENTIFICATION

The sensor housing is tagged with a type sticker containing the product description and the serial number. It also indicates which side of the sensor is the top side.

Sticker example:

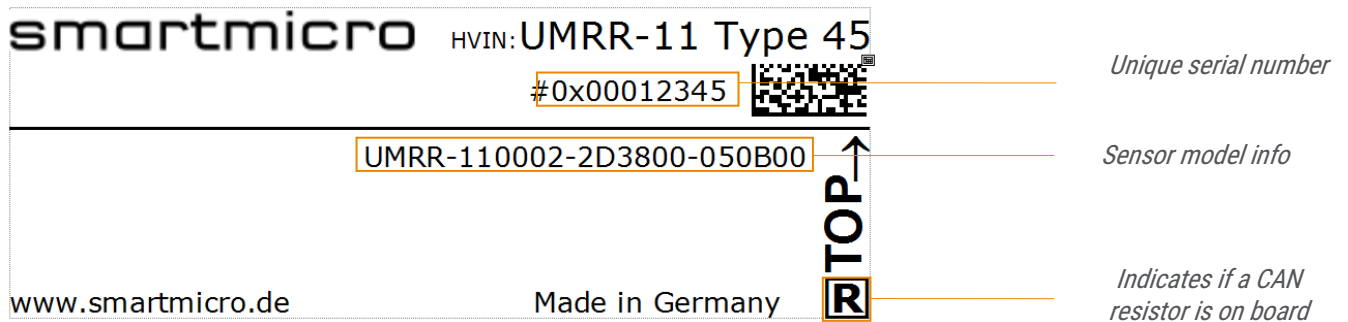

Additionally, the DSP board and the RF board have their own unique serial numbers.

### 3 GENERAL PERFORMANCE DATA

Parameter	Value
Operating Frequency <sup>2</sup>	24.0...24.25GHz
Range	Minimum <sup>3</sup> 1m   3ft
	Max.: Passenger Car <sup>4</sup> 160m   525ft (at 20dBm) or 130m   426ft (at 12.7dBm)
	Max.: Truck <sup>4</sup> 219m   719ft (at 20dBm) or 190m   623ft (at 12.7dBm)
	Instrumented <sup>5</sup> 219m   719ft (low bandwidth) or 170m   558ft (high bandwidth)
	Separation <sup>3</sup> 2.06m   6.8ft
	Accuracy < ±0.25m   < ±0.82ft
Speed	Min./Max. -320...+320km/h   -199...+199mph
	Separation <sup>3</sup> 0.35m/s   0.75mph
	Accuracy <sup>3 6</sup> < ±0.18m/s; < ±0.65km/h   0.4mph or ±1% (bigger of)
Angle	Field of View: Azimuth <sup>7</sup> -22...+22°
	Field of View: Elevation <sup>7</sup> -12...+12°
	Accuracy: Azimuth <sup>8</sup> < 1°
	Separation Azimuth <sup>9</sup> 20°
	Accuracy: Elevation <sup>8</sup> < 1°
<b>Mechanical Details</b>	
Weight	≤ 360g   ≤ 12.7oz
Dimensions (H/W/D)	110 x 99 x 31.7mm   4.3 x 3.9 x 1.3in (plus connector)
<b>Further Information</b>	
Initialization Time	< 10s
Processing Latency	2 cycles
Operating Voltage <sup>10</sup>	8...32V
Power Consumption <sup>11</sup>	4.5 ... 5.5W
Bandwidth	< 250MHz
Max. Transmit Power (EIRP)	<20dBm
Operating & Storage Temperature	-40...+85°C   -40...+185°F
Interfaces <sup>12</sup>	RS485 full duplex; Ethernet 10/100; 1xCAN V2.0b (passive)
Connector	Hirose LF10 series
Shock / Vibration	100g <sub>rms</sub> / 14g <sub>rms</sub>
Relative Humidity	0...95% (non-condensing)
IP <sup>13</sup>	67
UV Resistance	ISO Certified
Pressure or Transport Altitude	0...10000m   0...32800ft

<sup>2</sup> In certain regions, the frequency interval starts at 24.05GHz.

<sup>3</sup> Depending on the waveform.

<sup>4</sup> Typical values; all values given for bore sight; they may vary depending on the clutter environment. Please note that the radar system can neither achieve a detection probability of 100% nor a false alarm rate equal to zero.

## MOUNTING POSITION

The sensor is usually mounted on a vertical pole at the roadside; no setback is required. Other mounting positions (gantry, mast arm, luminaire) are possible.

## START-UP TIME

After powering up or resetting, sensor readings meet the specified performance in <10s.

### 3.1 SELF-DIAGNOSIS

The sensor cyclically reports a status message providing the following information: sensor run time, sensor cycle time, sensor mode and diagnosis information.

The sensor has a self-diagnosis feature to allow limited fail-safe capabilities, detecting for example:

- Sensor blindness
- Rain
- Detection and automatic suppression of RF interference (signals from other radar sensors in same frequency band)

Additionally, the radar is equipped with a sensor that facilitates measuring roll and pitch alignment.

### 3.2 SENSOR NETWORK

Sensors are typically used standalone. However, at intersections up to four sensors can be connected to one TMIB (interface board to intersection controllers; available as accessory) using separate configurable frequency channels, which avoid mutual interference.

<sup>5</sup> The instrumented range indicates the maximum range at which the sensor can effectively process detections.

<sup>6</sup> The speed accuracy is measured at bore sight on an object with a constant radial speed.

<sup>7</sup> The total field of view is an angle interval in which reflectors can be detected; 3dB field of view is narrower.

<sup>8</sup> Typical value; measured at target output level at bore sight, for a point reflector showing >23dB SNR. Error may increase towards larger angles. In addition to this angle error, angle may drift over temperature, typically -1deg to + 1deg over specified operation temperature interval.

<sup>9</sup> Measured on point reflectors at bore sight with S/N >30dB.

<sup>10</sup> Measured at the connector.

<sup>11</sup> Depending on supply voltage and temperature; power consumption increases with supply voltage and with temperature.

<sup>12</sup> It is recommended to use an external surge protection for power, CAN, RS485, Ethernet and other interface ports.

<sup>13</sup> IP67 only when connector or cap is attached.

### 3.3 ETHERNET CONNECTION

The sensor supports UDP via Ethernet in a Local Area Network (LAN). Communication over low bandwidth environments or routed networks such as the world wide web are not supported.

Features:

- Ethernet standards IPv4, ARP, IGMP, IP multicast and UDP
- Support of DHCP
- smartmicro’s proprietary communication protocol “smartmicro transport protocol” with:
  - o IP/UDP Multicast based discovery protocol
  - o Client ID based setup
  - o Sensor data transmission

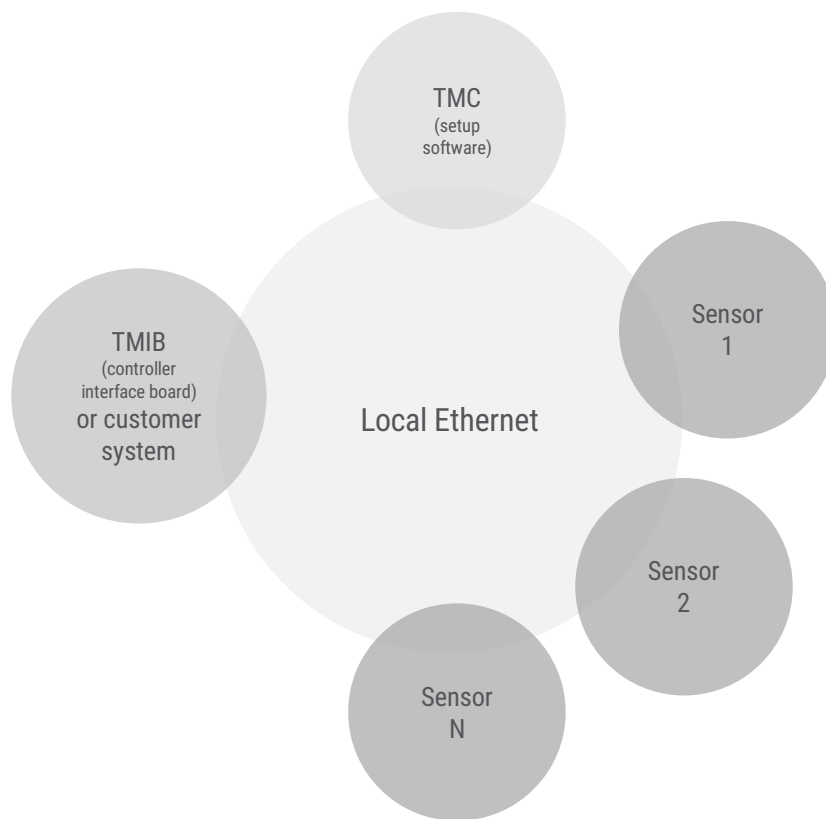

## 4 APPLICATION-SPECIFIC CHARACTERISTICS

The sensor can be used for the following different applications: intersection management, highway management and enforcement.

### 4.1 INTERSECTION MANAGEMENT

At intersections the sensor is typically used for combined stop bar detection (true presence detection) and lane-specific advance detection (exploiting the long-range). Other features of the sensor are:

- Queue length measurement
- Custom trigger conditions (e.g. location, vehicle speed, classification)
- ETA measurement
- Speed measurement

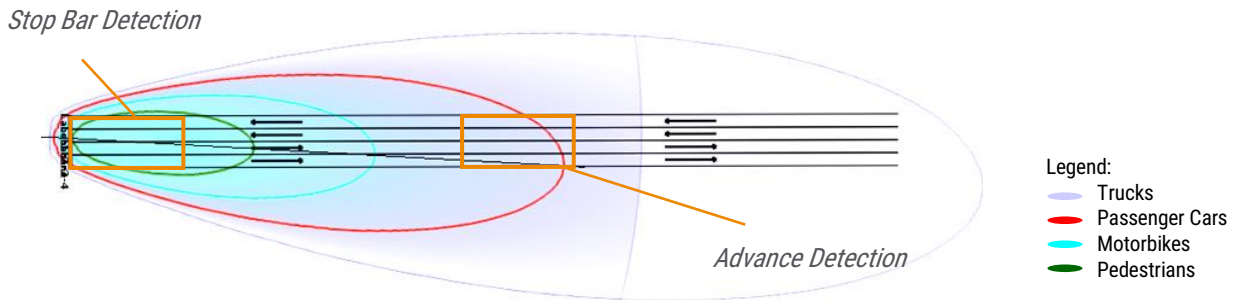

Standard configuration:

Parameter	Typical Values (min...max.)	
Mounting Height <sup>14</sup>	6m (1...10m)   20ft (3...33ft)	
Angle <sup>15</sup>	Sensor Azimuth Angle	-8° (-15...+15°)
	Sensor Elevation Angle <sup>16</sup>	-4° (-9...0°)
Stop Bar Setting <sup>17, 18</sup>	25m (20...50m)   82ft (66...164ft)	
Advance Detection Setting <sup>18</sup>	145m (50...180m)   476ft (164...591ft)	
Further Information		
Cycle Time <sup>19</sup>	75ms	

<sup>14</sup> The mounting height may affect the maximum detection range. Occlusion needs to be considered.

<sup>15</sup> The best performance is typically achieved at the center of the given angular range.

<sup>16</sup> These values are application specific. For gantry montage a steeper elevation angle is possible but limiting the maximum range. A negative elevation angle means that the sensor is pointing towards the road.

<sup>17</sup> Do not use stop bar distances below 20m (at max. sensor elevation mounting angle -9°).

<sup>18</sup> Outside the recommended range, vehicle drops are more likely.

<sup>19</sup> Typical value; may be higher depending on the number of detected radar targets.

## 4.2 HIGHWAY MANAGEMENT

On highways and country roads, the sensor can be utilized to count and classify traffic. Usually, statistic details are selected and reported in configurable intervals. Otherwise, already collected statistic data can be retrieved in push mode. Every vehicle can be displayed as per vehicle record (PVR) in real-time.

Other features of the sensor are wrong way detection, support of incident detection and speed measurement. The sensor delivers the following data:

- Classification
- Volume
- Occupancy
- Average speed
- Vehicle presence
- 85 percentile speed
- Headway
- Gap
- Wrong-way detection

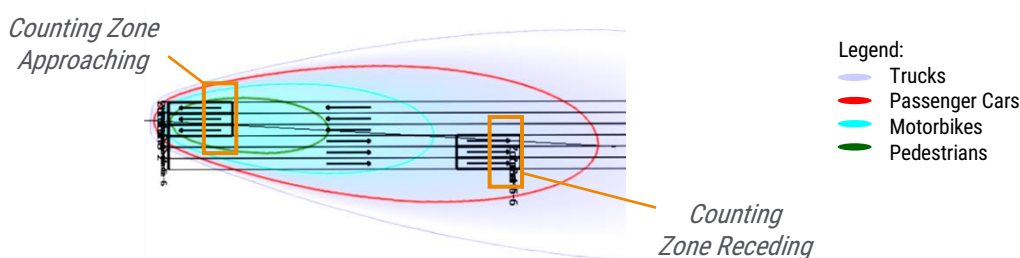

Standard configuration:

Parameter		Typical Values (min...max.)
Mounting Height <sup>20</sup>		6m (4...10m)   20ft (13...33ft)
Angle <sup>21</sup>	Sensor Azimuth Angle	-8° (-15...+15°)
	Sensor Elevation Angle <sup>22</sup>	-4° (-9...0°)
Counting Zone Setting <sup>23</sup>	Approaching	25-45m (20m...50m)   82-148ft (66...164ft)
	Receding	80-100m (50m...105m)   262-328ft (164...344ft)
Setback		1m (0...10m)   3ft (0...33ft)
Further Information		
Counting Accuracy <sup>24</sup>		> 95%
Classification Accuracy <sup>24</sup>		> 80%
Cycle Time <sup>25</sup>		75ms
Classes		7 (Pedestrian, Bicycle, Motorbike, Passenger Car, Transporter, Truck/Bus, Long Truck)

<sup>20</sup> The mounting height may affect the maximum detection range. Occlusion needs to be considered.

<sup>21</sup> The best performance is typically achieved at the center of the given angular range.

<sup>22</sup> These values are application-specific. For gantry montage a steeper elevation angle is possible but limiting the maximum range. A negative elevation angle means that the sensor is pointing towards the road.

<sup>23</sup> Outside the recommended range, vehicle drops are more likely.

<sup>24</sup> This is a typical value for a sensor that is properly installed at a suitable location. The counting and classification accuracy mainly depend on the mounting height and the traffic density as well as other factors.

<sup>25</sup> Typical value; may be higher depending on the number of detected radar targets.

### 4.3 TRAFFIC ENFORCEMENT

For traffic enforcement purposes the sensor can be used for combined lane-specific speed and red-light enforcement. The sensor can track 64 objects simultaneously<sup>26</sup>.

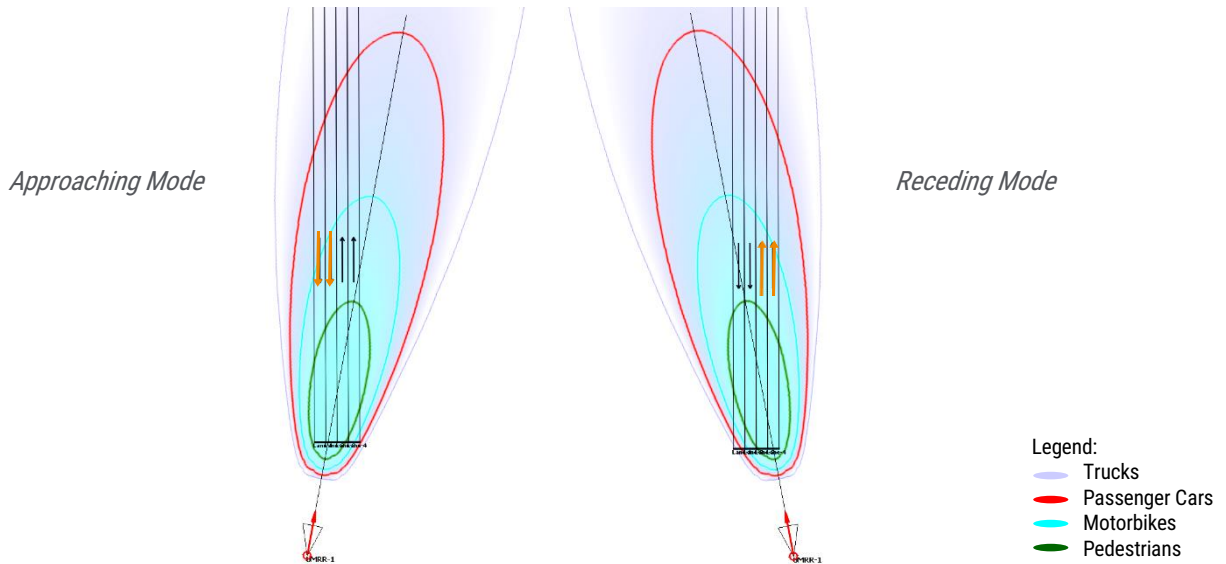

Standard configuration:

Parameter	Typical Values (min...max.)	
	Approaching Mode	Receding Mode
Mounting Height <sup>27</sup>	4/6m (1...10m)   13/20ft (0...33ft)	4m (1...10m) <sup>27</sup>   13ft (3...33ft)
Angle <sup>28</sup>	Sensor Azimuth Angle	-8° (-35...+35°)
	Sensor Elevation Angle <sup>29</sup>	-6° (-9...0°)
Photo Trigger Setting <sup>30</sup>	35m (20...50m)   114ft (66...164ft)	45m (20...50m)   148ft (66...164ft)
Further Information		
Speed Accuracy <sup>31</sup>	< ±0.28m/s ±1% (bigger of)	
Track Initialization Time	6...10 cycles	
Cycle Time <sup>32</sup>	58ms	

<sup>26</sup> Up to 126 objects can be tracked using a special firmware.

<sup>27</sup> The mounting height may affect the maximum detection range. Occlusion needs to be considered.

<sup>28</sup> The best performance is typically achieved at the center of the given angular range.

<sup>29</sup> These values are application specific. For gantry montage a steeper elevation angle is possible but limiting the maximum range. A negative elevation angle means that the sensor is pointing towards the road.

<sup>30</sup> Outside the recommended range, vehicle drops are more likely.

<sup>31</sup> The speed accuracy is measured on an object having a constant radial speed, at bore sight.

<sup>32</sup> Typical value; may be higher depending on the number of detected radar targets.

## 5 COMPLIANCES

The sensor model complies with the following EU directives:

- RED 2014/53/EU
- RoHS 2011/65/EU
- EC 1907/2006 REACH
- EAC TP TC 020/2011
- DIN EN 60950-22, Paragraph 8.2 (UV resistance)

Applied Standards:

- Spectrum Usage:
  - o EN 300 440 V2.1.1
- EMC:
  - o EN 301 489-1 V2.2.0
  - o EN 301 489-3 V2.1.1
- Health and Safety:
  - o EN 62311: 2008
  - o EN 62368-1: 2014 + AC: 2015

Regarding operating conditions like temperature, vibration etc., this sensor model was tested and certified by independent test labs to comply with:

- NEMA TS-2 2003

Regarding spectrum usage, this sensor model was tested and certified by independent test labs (formally approved by a test lab or notified body):

- EU RED directive
- FCC part 15.245 and 15.249
- RSS-310
- RSS-210

This sensor model is also generally compliant with the following regional regulations (but may not be formally tested/approved):

- SRRC
- KCC
- MIIT
- NCC

**Note:** This statement of compliance means that the sensor allows operation compliant to the listed standards. However, not all standards are certified through test labs. Formal frequency approval or registration is not accomplished for all countries. In certain countries or regions, a customer-specific local frequency approval is reasonable. smartmicro supports customers throughout this process.

For certain configurations of this sensor the accuracy of speed and other measured values was tested and certified by the Swiss Federal Institute of Metrology METAS.



## 6 LEGAL DISCLAIMER NOTICE

All products, product specifications and data in this document may be subject to change without notice to improve reliability, function or otherwise.

Not all products and/or product features may be available in all countries and regions. For legal reasons features may be deleted from products or smartmicro may refuse to offer products. Statements, technical information and recommendations contained herein are believed to be accurate as of the stated date. smartmicro disclaims any and all liability for any errors, inaccuracies or incompleteness contained in this document or in any other disclosure relating to the product.

To the extent permitted by applicable law, smartmicro disclaims (i) any and all liability arising out of the application or use of the product or the data contained herein, (ii) any and all liability of damages exceeding direct damages, including - without limitation - indirect, consequential or incidental damages, and (iii) any and all implied warranties, including warranties of the suitability of the product for particular purposes.

Statements regarding the suitability of products for certain types of applications are based on smartmicro's knowledge of typical requirements that are often placed on smartmicro products in generic/general applications. Statements about the suitability of products for a particular/specific application, however, are not binding. It is the customer's/user's responsibility to validate that the product with the specifications described is suitable for use in the particular/specific application. Parameters and the performance of products may deviate from statements made herein due to particular/specific applications and/or surroundings. Therefore, it is important that the customer/user has thoroughly tested the products and has understood the performance and limitations of the products before installing them for final applications or before their commercialization. Although products are well optimized to be used for the intended applications stated, it must also be understood by the customer/user that the detection probability may not be 100% and that the false alarm rate may not be zero.

The information provided, relates only to the specifically designated product and may not be applicable when the product is used in combination with other materials or in any process not defined herein. All operating parameters, including typical parameters, must be validated for each application by the customer's/user's technical experts. Customers using or selling smartmicro products for use in an application which is not expressly indicated do so at their own risk.

This document does not expand or otherwise modify smartmicro's terms and conditions of purchase, including but not being limited to the warranty. Except as expressly indicated in writing by smartmicro, the products are not designed for use in medical, life-saving or life-sustaining applications or for any other application in which the failure of the product could result in personal injury or death.

No license, expressed or implied, by estoppel or otherwise, to any intellectual property rights is granted by this document or by any conduct of smartmicro. Product names and markings noted herein may be trademarks of their respective owners.

Please note that the application of the product may be subject to standards or other regulations that may vary from country to country. smartmicro does not guarantee that the use of products in the applications described herein will comply with such regulations in any country. It is the customer's/user's responsibility to ensure that the use and incorporation of products comply with regulatory requirements of their markets.

If any provision of this disclaimer is, or is found to be, void or unenforceable under applicable law, it will not affect the validity or enforceability of the other provisions of this disclaimer.